

# PTC PTF

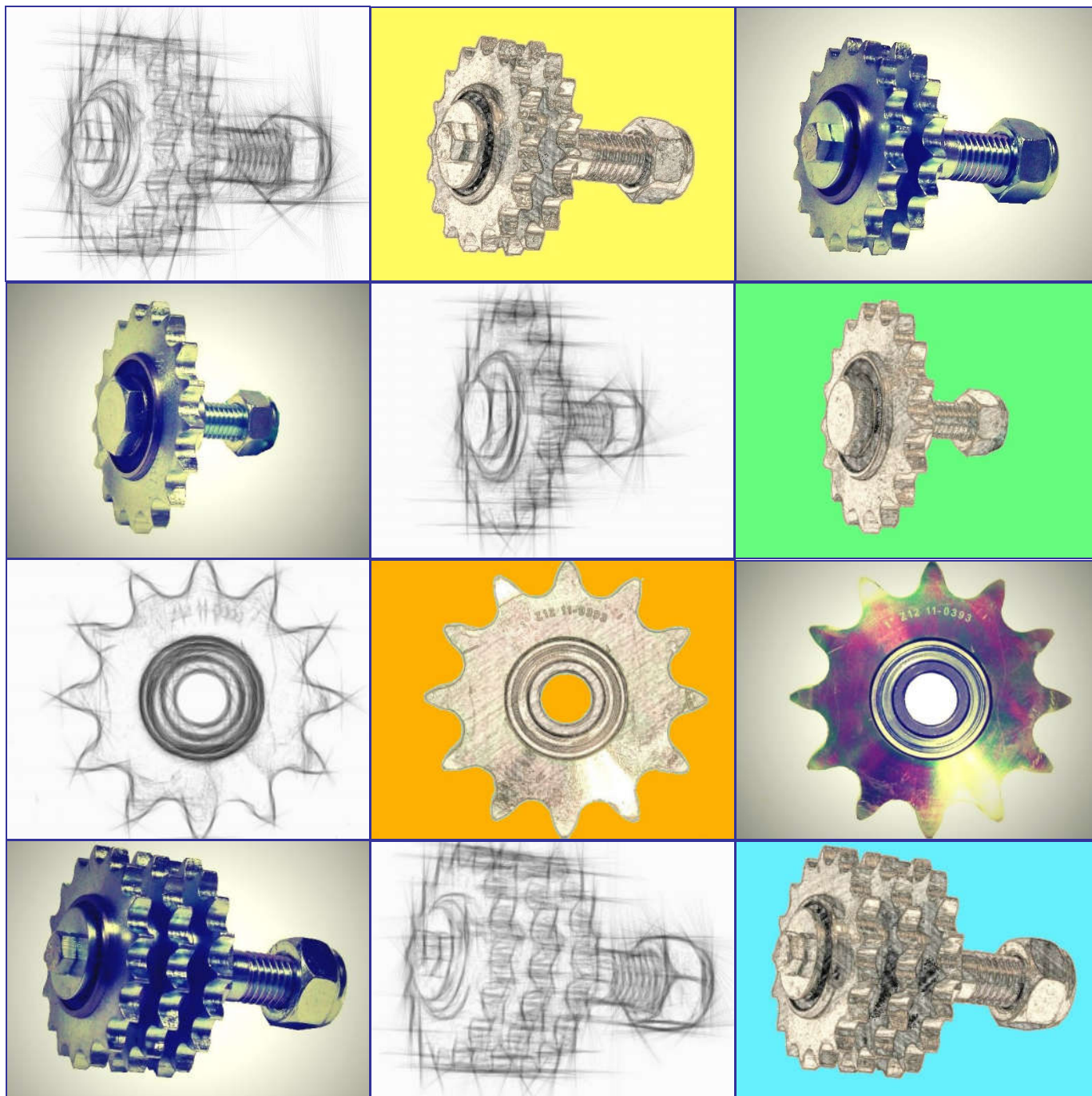

I

GB



**TECNIDEA CIDUE**  
S.r.l.



**PIGNONI TENDICATENA - Tipo: PTC / CHAIN TENSIONER PINIONS - Type: PTC**

**MATERIALI** Acciaio

**TRATTAMENTI** Corona con trattamento di zincatura.

**IMPIEGO** Il pignone è costituito da una corona in acciaio, montata su cuscinetti nazionali a base maggiorata. A richiesta si possono fornire con cuscinetti INA. Sono utilizzati per tensionamenti manuali o per la realizzazione di rinvi.

**MATERIALS** Steel

**TREATMENTS** The crown wheel is zinc plated

**USE** The sprocket consists of a steel crown, installed on enlarged bearings. On demand we can supply the sprocket with INA bearing.

They are used for manual chain tensioning or for the realization of gear transmissions.

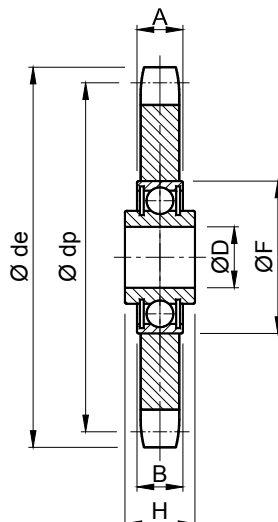

Tipo Type	Cod. N°	Catena Chain	Z	Ø de	Ø dp	A	B	Ø D	Ø F	H	Peso Weight in kg
PTC 1-21	TB001195	3/8" x 7/32"	21	68.0	63.90	5.3	12	16 <sup>+0.26</sup> <sub>+0.13</sub>	40	18.3	0.17
PTC 2-14	TB001216	1/2" x 5/16"	14	61.9	57.07	7.2	12	16 <sup>+0.26</sup> <sub>+0.13</sub>	40	18.3	0.15
PTC 2-15	TB001205	1/2" x 5/16"	15	66.8	61.09	7.2	12	16 <sup>+0.26</sup> <sub>+0.13</sub>	40	18.3	0.16
PTC 2-16	TB001196	1/2" x 5/16"	16	69.5	65.10	7.2	12	16 <sup>+0.26</sup> <sub>+0.13</sub>	40	18.3	0.18
PTC 2-17	TB001175	1/2" x 5/16"	17	74.0	69.11	7.2	12	16 <sup>+0.26</sup> <sub>+0.13</sub>	40	18.3	0.21
PTC 2-18	TB001197	1/2" x 5/16"	18	77.8	73.14	7.2	12	16 <sup>+0.26</sup> <sub>+0.13</sub>	40	18.3	0.23
PTC 3-14	TB001198	5/8" x 3/8"	14	78.0	71.34	9.1	12	16 <sup>+0.26</sup> <sub>+0.13</sub>	40	18.3	0.24
PTC 3-15	TB001215	5/8" x 3/8"	15	83.0	76.36	9.1	12	16 <sup>+0.26</sup> <sub>+0.13</sub>	40	18.3	0.28
PTC 3-16	TB001176	5/8" x 3/8"	16	88.3	81.37	9.1	12	16 <sup>+0.26</sup> <sub>+0.13</sub>	40	18.3	0.34
PTC 3-17	TB001199	5/8" x 3/8"	17	93.0	86.39	9.1	12	16 <sup>+0.26</sup> <sub>+0.13</sub>	40	18.3	0.36
PTC 4-13	TB001204	3/4" x 7/16"	13	87.5	79.59	11.1	12	16 <sup>+0.26</sup> <sub>+0.13</sub>	40	18.3	0.42
PTC 4-14	TB001177	3/4" x 7/16"	14	93.8	85.61	11.1	12	16 <sup>+0.26</sup> <sub>+0.13</sub>	40	18.3	0.44
PTC 4-15	TB001200	3/4" x 7/16"	15	99.8	91.63	11.1	12	16 <sup>+0.26</sup> <sub>+0.13</sub>	40	18.3	0.46
PTC 5-12	TB001201	1" x 17.02mm	12	109.0	98.14	16.2	14	20 <sup>+0.10</sup> <sub>-0.00</sub>	47	17.7	0.74
PTC 6-13	TB001202	1"1/4 x 3/4"	13	147.8	132.65	18.5	15	25 <sup>+0.00</sup> <sub>-0.01</sub>	52	21.0	1.60
PTC 7-11/20	TB001203	1"1/2 x 1"	11	149.0	135.21	24.1	30.0	20 <sup>+0.00</sup> <sub>-0.01</sub>	52	30.0	2.07
PTC 7-11/25	TBA01203	1"1/2 x 1"	11	149.0	135.21	24.1	30.0	25 <sup>+0.00</sup> <sub>-0.01</sub>	52	30.0	2.09



**CUSCINETTI A SFERA / BALL BEARING**

Tipo Type	Cod. N°	d	D	A	B	Peso Weight in kg
203 KRR AH 02	BU008530	16 <sup>+0.13</sup> <sub>+0.26</sub>	40	12	18.3	0.082
204 KRR	BU008531	20 <sup>+0.10</sup> <sub>-0.00</sub>	47	14	17.7	0.115
205 KRR	BU008534	25 <sup>+0.00</sup> <sub>-0.01</sub>	52	15	21.0	0.149

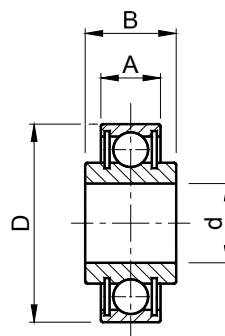

**Tendicatena - Tipo: PTF / Chain tensioners - Type: PTF**

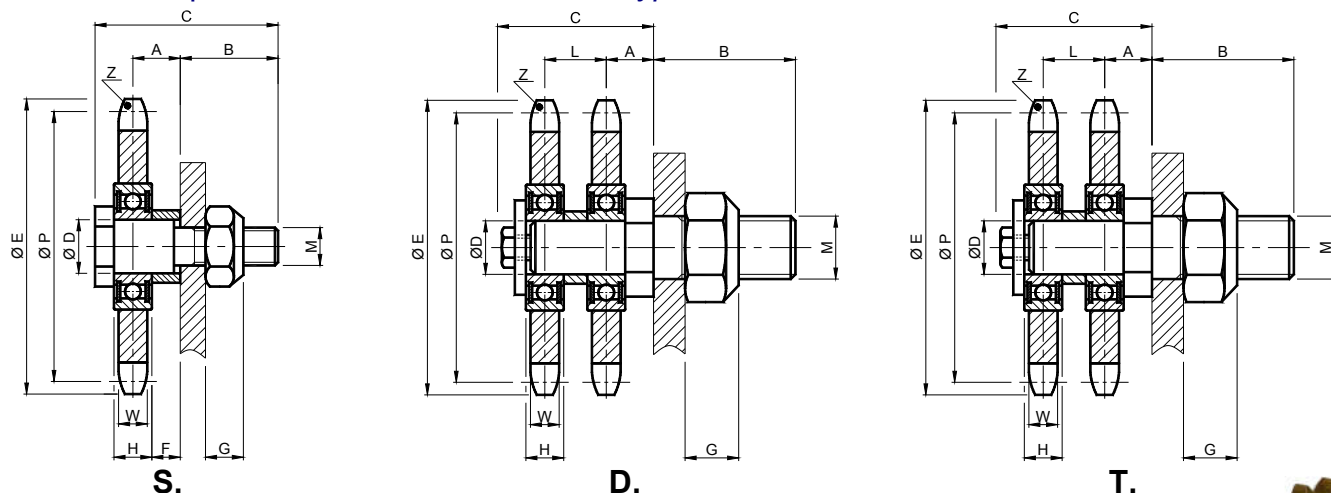

**MATERIALI** Acciaio / **MATERIALS** Steel

**TRATTAMENTI** Acciaio zincato / **TREATMENTS** Zinc plated

**IMPIEGO** Il pignone è costituito da una corona in acciaio, montata su cuscinetti unificati.  
I tendicatena tipo PTF sono soprattutto utilizzati sugli elementi elastici CRESA.

**USE** The sprocket consists of a steel crown, installed on unified bearings.  
The sprockets type PTF are mostly used on elastic elements CRESA.



**Semplice - Simplex (S.):**

Tipo Type	Cod. N°	Catena Chain	A	B	C	ØD	F	G	H	M	ØE	ØP	W	Z	Tipo Type RE	Peso Weight in kg
PTF 03 B1	PT010010	5mm	7	15	28	6	4	6	6	M 6	29.00	27.20	2.3	17	RE 10	0.100
PTF 04 B1	PT010011	6mm	7	15	28	6	4	6	6	M 6	31.10	28.86	2.6	15	RE 10	0.110
PTF 05 B1	PT010012	8mm	7.5	16	30	8	4	8	7	M 8	39.20	35.95	2.8	14	RE 10	0.120
PTF 06 B1	PT010013	3/8" x 7/32"	12	22	44	12	7	10	10	M10	55.50	51.83	5.3	17	RE 20	0.135
PTF 081.1	PT010014	1/2" x 1/8"	12	22	44	12	7	10	10	M10	59.40	53.06	3.0	13	RE 20	0.140
PTF 083.1	PT010015	1/2" x 3/16"	12	22	44	12	7	10	10	M10	59.40	53.06	4.5	13	RE 20	0.145
PTF 08 B1	PT010016	1/2" x 5/16"	15	26	53	17	9	12	12	M12	74.00	69.11	7.2	17	RE 30	0.280
PTF 10 B1	PT010017	5/8" x 3/8"	15	26	53	17	9	12	12	M12	88.30	81.37	9.1	16	RE 40	0.410
PTF 12 B1	PT010018	3/4" x 7/16"	15	26	53	17	9	12	13	M12	93.80	85.61	11.1	14	RE 40	0.490
PTF 16 B1	PT010019	1" x 17.02mm	24.8	28.2	66	20	17.8	17	14	M20	109.70	98.14	16.2	12	RE 50	0.960
PTF 20 B1	PT010020	1"1/4 x 3/4"	40	50	115	30	30.5	21	19	M24	137.00	122.68	18.5	12	RE 60	2.350
PTF 24 B1	PT010021	1"1/2 x 1"	50	74	155	40	38.5	29	23	M36	161.00	147.22	24.1	12	RE 60 RE 70	3.250

**Doppio - Duplex (D.):**

Tipo Type	Cod. N°	Catena Chain	A	B	C	ØD	G	H	L	M	ØE	ØP	W	Z	Tipo Type RE	Peso Weight in kg
PTF 06 B2	PT010030	3/8" x 7/32"	12	35	33	12	12	10	10.24	M12	55.50	51.83	5.3	17	RE 30	0.235
PTF 08 B2	PT010031	1/2" x 5/16"	15	45	44	17	17	12	13.92	M18	74.00	69.11	7.2	17	RE 40	0.600
PTF 10 B2	PT010032	5/8" x 3/8"	15	45	46.6	17	17	12	16.59	M20	88.30	81.37	9.1	16	RE 50	0.900
PTF 12 B2	PT010033	3/4" x 7/16"	15	45	49.5	17	17	12	19.46	M20	93.80	85.61	11.1	14	RE 50	1.100
PTF 16 B2	PT010034	1" x 17.02mm	24	55	71.8	20	21	14	31.88	M24	109.70	98.14	16.2	12	RE 60	2.000

**Tripla - Triplex (T.):**

Tipo Type	Cod. N°	Catena Chain	A	B	C	ØD	G	H	L	M	ØE	ØP	W	Z	Tipo Type RE	Peso Weight in kg
PTF 06 B3	PT010040	3/8" x 7/32"	12	35	43	12	12	10	10.24	M12	55.50	51.83	5.3	17	RE 30	0.325
PTF 08 B3	PT010041	1/2" x 5/16"	15	45	58	17	17	12	13.92	M18	74.00	69.11	7.2	17	RE 40	0.800
PTF 10 B3	PT010042	5/8" x 3/8"	15	45	63.2	17	17	12	16.59	M20	88.30	81.37	9.1	16	RE 50	1.300
PTF 12 B3	PT010043	3/4" x 7/16"	15	45	69	17	17	12	19.46	M20	109.70	98.14	11.1	14	RE 50	1.600

Il cliente dovrà allargare il foro sull'elemento elastico tipo CRESA o ARCO dove necessario.  
The client must widen the hole in the elastic element type CRESA or ARCO where necessary.

**Albero - Tipo: AXPT / Shaft - Type: AXPT**

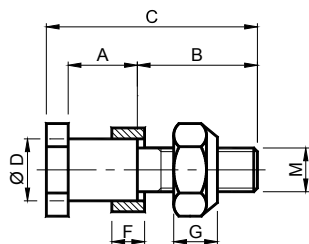

**S.**

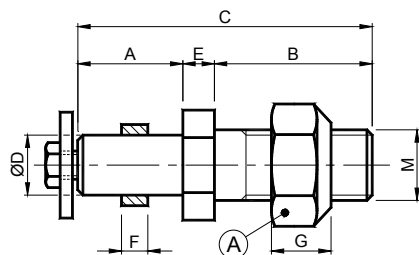

**D.**

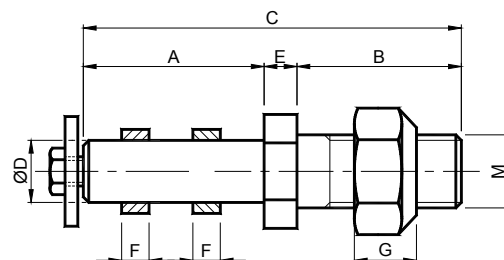

**T.**

**MATERIALI** Perno, distanziali e dado autobloccante (A) in acciaio.  
**TRATTAMENTI** Zincatura.

**MATERIALS** Pin, spacers and self-locking nut (A) made of steel.  
**TREATMENTS** Zinc plated.



**Semplice - Simplex (S.):**

Tipo Type	Cod. N°	A	B	C	ØD	F	G	M	Tipo Type RE	Peso Weight in kg
AXPTM06	PT010110	10	15	28	6	4	6	M6	RE 10	0.040
AXPTM08	PT010111	11	16	30	8	4	8	M8	RE 10	0.050
AXPTM10	PT010112	16.5	22.5	44	12	7	10	M10	RE 20	0.060
AXPTM12	PT010113	20	27	53	17	9	12	M12	RE 30 RE 40	0.100
AXPTM20	PT010114	31	29	66	20	17.8	17	M20	RE 50	0.240
AXPTM24	PT010115	47.5	52	115	30	30.5	21	M24	RE 60	0.300
AXPTM36	PT010116	59.5	76	155	40	38.5	29	M36	RE 60 RE 70	0.500

**Doppio - Duplex (D.):**

Tipo Type	Cod. N°	A	B	C	ØD	E	F	G	M	Tipo Type RE	Peso Weight in kg
AXPT06B2	PT010117	19.5	35	61.5	12	7	/	12	M12	RE 30	0.085
AXPT08B2	PT010118	24.5	45	78.5	17	9	2	17	M18	RE 40	0.240
AXPT10B2	PT010119	27	45	81	17	9	4.6	17	M20	RE 50	0.280
AXPT12B2	PT010120	30	45	84	17	9	7.5	17	M20	RE 50	0.320
AXPT16B2	PT010121	44	55	116	20	17	17.8	21	M24	RE 60	0.560

**Tripla - Triplex (T.):**

Tipo Type	Cod. N°	A	B	C	ØD	E	F	G	M	Tipo Type RE	Peso Weight in kg
AXPT06B3	PT010122	29.5	35	71.5	12	7	/	12	M12	RE 30	0.100
AXPT08B3	PT010123	38.5	45	92.5	17	9	2	17	M18	RE 40	0.260
AXPT10B3	PT010124	44	45	98	17	9	4.6	17	M20	RE 50	0.370
AXPT12B3	PT010125	50	45	104	17	9	7.5	17	M20	RE 50	0.430

Il cliente dovrà allargare il foro sull'elemento elastico tipo CRESA o ARCO dove necessario.  
*The client must widen the hole in the elastic element type CRESA o ARCO where necessary.*

**PIGNONI TENDICATENA - Tipo: PF / CHAIN TENSIONER PINIONS - Type: PF**

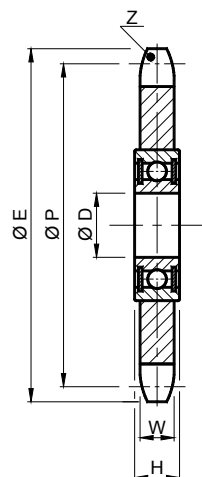

**MATERIALI** Acciaio

**TRATTAMENTI** Corona con trattamento di zincatura.

**IMPIEGO** Il pignone è costituito da una corona in acciaio, montata su cuscinetti unificati. Sono utilizzati per tensionamenti manuali o per la realizzazione di rinvi.

**MATERIALS** Steel

**TREATMENTS** The crown wheel is zinc plated

**USE** The sprocket consists of a steel crown, installed on unified bearings.

They are used for manual chain tensioning or for the realization of gear transmissions.

Tipo Type	Cod. N°	Catena Chain	ØD	H	ØE	ØP	W	Z	Peso Weight in kg
PF 03-17	PT010210	5mm	6	6	29.00	27.20	2.3	17	0.060
PF 04-15	PT010211	6mm	6	6	31.10	28.86	2.6	15	0.070
PF 05-14	PT010212	8mm	8	7	39.20	35.95	2.8	14	0.070
PF 06-17	PT010213	3/8" x 7/32"	12	10	55.50	51.83	5.3	17	0.075
PF 081-13	PT010214	1/2" x 1/8"	12	10	59.40	53.06	3.0	13	0.080
PF 083-13	PT010215	1/2" x 3/16"	12	10	59.40	53.06	4.5	13	0.085
PF 08-17	PT010216	1/2" x 5/16"	17	12	74.00	69.11	7.2	17	0.180
PF 10-16	PT010217	5/8" x 3/8"	17	12	88.30	81.37	9.1	16	0.310
PF 12-14	PT010218	3/4" x 7/16"	17	13	93.80	85.61	11.1	14	0.390
PF 16-12	PT010219	1" x 17.02mm	20	14	109.70	98.14	16.2	12	0.720
PF 20-12	PT010220	1"1/4 x 3/4"	30	19	137.00	122.68	18.5	12	2.050
PF 24-12	PT010221	1"1/2 x 1"	40	23	161.00	147.22	24.1	12	2.750

Su richiesta è possibile avere pignoni con numero diverso da quello indicato in tabella.

*On specific request, you can have the pinions with different number of teeth compared to those indicated in the table.*

Type - *Tipo*: PTX

**USE** Stainless steel idler sprockets  
*Pignoni tendicatena INOX*

**MATERIALS** Stainless Steel  
**USE** Idlersprocket consists of a stainless steel crown, installed on stainless steel bearings.

They are used for manual chain tensioning or for the realization of gear transmissions.

**MATERIALI** Acciaio INOX.  
**IMPIEGO** Il pignone è costituito da una corona in acciaio INOX, montata su cuscinetti INOX a base maggiorata.

Sono utilizzati per tensionamenti manuali o per la realizzazione di rinvii.

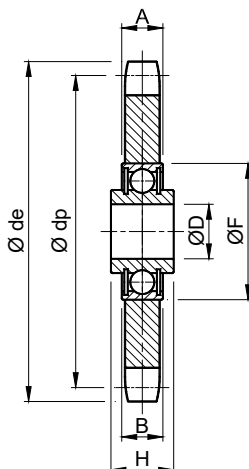

Type <i>Tipo</i>	Cod. N°	Chain <i>Catena</i>	Z	Ø de	Ø dp	A	B	Ø D	Ø F	H	Weight / <i>Peso</i> [kg]
PTX 1-21 INOX	TB001827	3/8" x 7/32"	21	68.0	63.90	5.3	12	16 <sup>+0.26</sup> / <sub>+0.13</sub>	40	18.3	0.17
PTX 2-16 INOX	TB001830	1/2" x 5/16"	16	69.5	65.10	7.2	12	16 <sup>+0.26</sup> / <sub>+0.13</sub>	40	18.3	0.18
PTX 2-18 INOX	TB001832	1/2" x 5/16"	18	77.8	73.14	7.2	12	16 <sup>+0.26</sup> / <sub>+0.13</sub>	40	18.3	0.23
PTX 3-17 INOX	TB001836	5/8" x 3/8"	17	93.0	86.39	9.1	12	16 <sup>+0.26</sup> / <sub>+0.13</sub>	40	18.3	0.36
PTX 4-15 INOX	TB001839	3/4" x 7/16"	15	99.8	91.63	11.1	12	16 <sup>+0.26</sup> / <sub>+0.13</sub>	40	18.3	0.46



**STAINLESS STEEL BALL BEARINGS - CUSCINETTI A SFERA INOX**

Type / <i>Tipo</i>	Cod. N°	d	D	A	B	Weight <i>Peso in</i> [kg]
203 KRR AH 02 INOX	BU008536	16 <sup>+0.13</sup> / <sub>+0.26</sub>	40	12	18.3	0.082

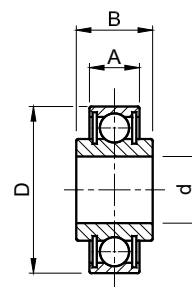

**APPLICATION EXAMPLES  
ESEMPI DI APPLICAZIONE**

