



附件 型号 XRP / XRP accessories

 XRP 塑性材质滚轮在自润滑轴承上安装，适用于皮带的张紧。工作温度应为 $\leq 70^{\circ}\text{C}$ 。所供应配件包括不锈钢螺钉螺栓。

 XRP plastic roller installed on self-lubricating bearings, suitable to tension the belts. The operating temperatures must be $\leq 70^{\circ}\text{C}$. The kits are delivered with stainless steel bolts and screws.

型号 Type	编号 n°	Size 	Size						重量 Weight [Kg]
			A	B	C	D	E	M	
XRP 1	RE011960	10	35	3	13	40	30	M 8	0.08
XRP 2/3	RE011962	20-30	45	6	16	53	40	M10	0.18
XRP 4	RE011964	40	60	8	21	70	60	M12	0.40

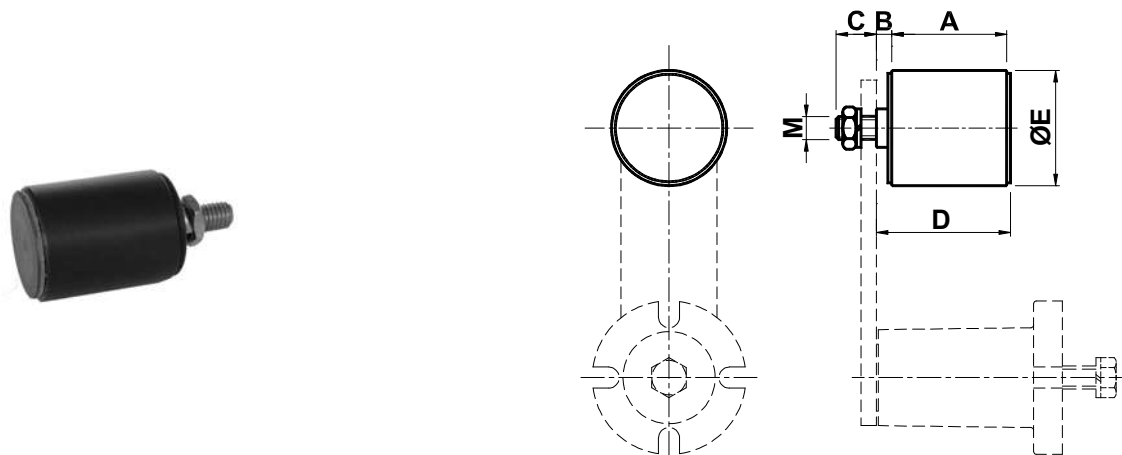

附件 型号 XRU / XRU accessories

 XRU 不锈钢滚轮在自润滑轴承上安装，适用于皮带的张紧。工作温度应为 $\leq 70^{\circ}\text{C}$ 。所供应配件包括不锈钢螺钉螺栓。

 XRU stainless steel roller installed on self-lubricating bearings, suitable to tension the belts. The operating temperatures must be $\leq 100^{\circ}\text{C}$. The kits are delivered with stainless steel bolts and screws.

型号 Type	编号 n°	Size 	Size						重量 Weight [Kg]
			A	B	C	D	E	M	
XRU 1	RE010970	10	35	3	13	40	30	M 8	0.16
XRU 2/3	RE010972	20-30	45	6	16	53	40	M10	0.37
XRU 4	RE010974	40	60	8	21	72	60	M16	0.85

