

皮带张紧装置配套元件 / KIT for belt-tighteners

聚酰胺滚轮 – 型号: RP

◎ 聚酰胺滚轮用 / 螺钉“M”

Rollerset of polyamid – Type: RP

◎ For polyamid-roller / Screw “M”



滚轮为塑性材料，在润滑轴承上安装。滚轮工作温度为 $\leq 70^{\circ}\text{C}$ 。

The roller is in plastic installed on greased bearings. Roller operating temperature $\leq 70^{\circ}\text{C}$.

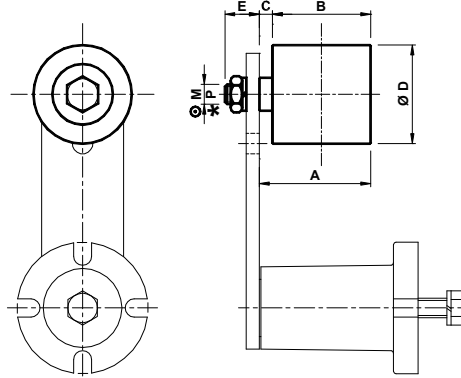

镀锌钢滚轮 – 型号: RU

* 镀锌钢滚轮用 / 螺钉“P”

Rollerset of galvanized steel – Type: RU

* For steel-roller / Screw “P”



滚轮为镀锌钢制，在润滑轴承上安装。滚轮工作温度为 $\leq 100^{\circ}\text{C}$ 。

The roller is in galvanized steel installed on greased bearings. Roller operating temperature $\leq 100^{\circ}\text{C}$.

型号 Type	编号 N°	重量 Weight in Kg	A	B	C	ØD	E	ØM	*P	尺寸 	型号 Type	编号 N°	重量 Weight in Kg
RP 1	RE011090	0.08	38	35	3	30	13	M 8	M 8	10	RU 1	AR070870	0.16
RP 2/3	RE011092	0.18	51	45	6	40	16	M10	M10	20-30	RU 2/3	AR070872	0.37
RP 4	RE011094	0.40	68	60	8	60	21	M12	M16	40	RU 4	AR070874	0.85
RP 5	RE011096	1.20	99	90	9	80	28	M20	M20	50	RU 5	AR070876	2.09
RP 6	RE011098	1.70	142	135	7	90	27	M20	M20	60	RU 6	AR070878	2.44

滑轮: SP (Z-A-B)

Pulley : SP (Z-A-B)

Scheibe: SP (Z-A-B)

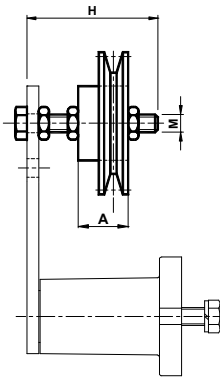
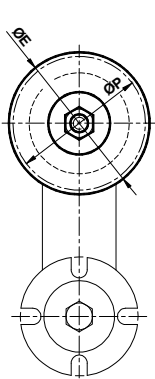

单“S”
Simplex “S”

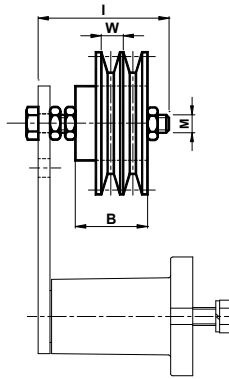

双“D”
Duplex “D”

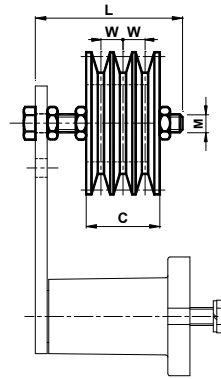

三“T”
Triplex “T”

配套元件由一个用于 V 型带的铸铁滑轮构成，在润滑轴承上安装。若有需要，我们可提供具不同轮廓或用于齿型皮带的滑轮。

The kit is composed of a cast-iron pulley for V-belts mounted on lubricated bearings. On request pulleys may be supplied with a different profile or for cogged belts.

型号 Type	S 编号 N°	D 编号 N°	T 编号 N°	皮带 Belt	尺寸 	A	B	C	ØE	H	I	L	M	ØP	W	重量 Weight in Kg		
																S.	D.	T.
SP 30-Z	RE011800	RE011802	RE011804	SPZ	30	24	35	40	67	55	60	70	M10	63	12	0.40	0.70	1.10
SP 40-A	RE011806	RE011808	RE011810	SPA	40	34	49	50	95,6	80	80	80	M12	90	15	1.00	1.70	1.80
SP 40-B	RE011812	RE011814		SPB	40	41	60		132	80	80		M12	125	19	1.90	2.80	
SP 50-B			RE011816	SPB	50			63	132			120	M16	125	19			3.50

若有要求，我们可提供将轴焊接在杆上的滑轮 / On request we can supply the pulley with the pin welded on the lever