

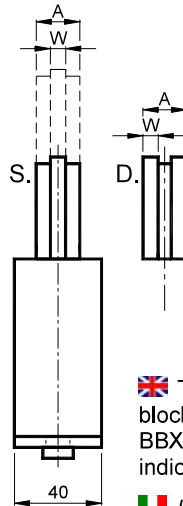

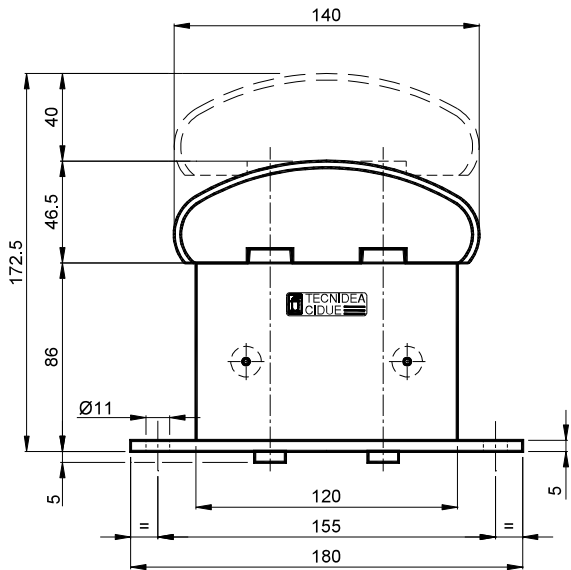



Type: **BBZVG – BBXVG** / Tipo: **BBZVG – BBXVG**



🇬🇧 Tensioners are made by BB elastic element and VG sliding block. Tensioners BBZVG are available with galvanized springs and BBXVG types with stainless steel springs; load values are indicated on page I-30. The travel is 40 mm.

🇮🇹 I tenditori sono composti dall'elemento elastico BC e la testa VG. I tenditori BBZVG sono disponibili con molle in acciaio zincato ed i tipi BBXVG con molle in acciaio inox; i valori di carico sono riportati a pag I-30. La corsa è di 40 mm.

		Zinc plated springs / Molle zincate				Stainless steel springs / Molle inox					
Chain Catena DIN 8187 ISO Pitch		BBZ+VG	BBZ	← VG →		A W		BBX	BBX+VG		
											
06-B1	3/8"x7/32"	BB10ZVG1S	BB 10 Z	BL010620	VG 1 S	BL010502	20	5	BB 10 X	BL011630	BB10XVG1S
06-B1	3/8"x7/32"	BB20ZVG1S	BB 20 Z	BL010622	VG 1 S	BL010502	20	5	BB 20 X	BL011632	BB20XVG1S
08-B1	1/2"x5/16"	BB10ZVG2S	BB 10 Z	BL010620	VG 2 S	BL010504	20	7	BB 10 X	BL011630	BB10XVG2S
08-B1	1/2"x5/16"	BB20ZVG2S	BB 20 Z	BL010622	VG 2 S	BL010504	20	7	BB 20 X	BL011632	BB20XVG2S
10-B1	5/8"x3/8"	BB20ZVG3S	BB 20 Z	BL010622	VG 3 S	BL010506	20	9	BB 20 X	BL011632	BB20XVG3S
10-B1	5/8"x3/8"	BB30ZVG3S	BB 30 Z	BL010624	VG 3 S	BL010506	20	9	BB 30 X	BL011634	BB30XVG3S
12-B1	3/4"x7/16"	BB20ZVG4S	BB 20 Z	BL010622	VG 4 S	BL010508	20	11	BB 20 X	BL011632	BB20XVG4S
12-B1	3/4"x7/16"	BB30ZVG4S	BB 30 Z	BL010624	VG 4 S	BL010508	20	11	BB 30 X	BL011634	BB30XVG4S
16-B1	1"x17.02mm	BB30ZVG5S	BB 30 Z	BL010624	VG 5 S	BL010510	25	16	BB 30 X	BL011634	BB30XVG5S
16-B1	1"x17.02mm	BB40ZVG5S	BB 40 Z	BL010626	VG 5 S	BL010510	25	16	BB 40 X	BL011636	BB40XVG5S
20-B1	1"1/4x3/4"	BB30ZVG6S	BB 30 Z	BL010624	VG 6 S	BL010512	25	18	BB 30 X	BL011634	BB30XVG6S
20-B1	1"1/4x3/4"	BB40ZVG6S	BB 40 Z	BL010626	VG 6 S	BL010512	25	18	BB 40 X	BL011636	BB40XVG6S
24-B1	1"1/2x1"	BB30ZVG7S	BB 30 Z	BL010624	VG 7 S	BL010514	30	24	BB 30 X	BL011634	BB30XVG7S
24-B1	1"1/2x1"	BB40ZVG7S	BB 40 Z	BL010626	VG 7 S	BL010514	30	24	BB 40 X	BL011636	BB40XVG7S
06-B2	3/8"x7/32"	BB10ZVG1D	BB 10 Z	BL010620	VG 1 D	BL010522	20	5	BB 10 X	BL011630	BB10XVG1D
06-B2	3/8"x7/32"	BB20ZVG1D	BB 20 Z	BL010622	VG 1 D	BL010522	20	5	BB 20 X	BL011632	BB20XVG1D
08-B2	1/2"x5/16"	BB20ZVG2D	BB 20 Z	BL010622	VG 2 D	BL010524	20	7	BB 20 X	BL011632	BB20XVG2D
10-B2	5/8"x3/8"	BB20ZVG3D	BB 20 Z	BL010622	VG 3 D	BL010526	25	9	BB 20 X	BL011632	BB20XVG3D
10-B2	5/8"x3/8"	BB30ZVG3D	BB 30 Z	BL010624	VG 3 D	BL010526	25	9	BB 30 X	BL011634	BB30XVG3D
12-B2	3/4"x7/16"	BB30ZVG4D	BB 30 Z	BL010624	VG 4 D	BL010528	30	11	BB 30 X	BL011634	BB30XVG4D
16-B2	1"x17.02mm	BB30ZVG5D	BB 30 Z	BL010624	VG 5 D	BL010530	48	16	BB 30 X	BL011634	BB30XVG5D
16-B2	1"x17.02mm	BB40ZVG5D	BB 40 Z	BL010626	VG 5 D	BL010530	48	16	BB 40 X	BL011636	BB40XVG5D
20-B2	1"1/4x3/4"	BB30ZVG6D	BB 30 Z	BL010624	VG 6 D	BL010532	55	18	BB 30 X	BL011634	BB30XVG6D
20-B2	1"1/4x3/4"	BB40ZVG6D	BB 40 Z	BL010626	VG 6 D	BL010532	55	18	BB 40 X	BL011636	BB40XVG6D
24-B2	1"1/2x1"	BB30ZVG7D	BB 30 Z	BL010624	VG 7 D	BL010534	70	24	BB 30 X	BL011634	BB30XVG7D
24-B2	1"1/2x1"	BB40ZVG7D	BB 40 Z	BL010626	VG 7 D	BL010534	70	24	BB 40 X	BL011636	BB40XVG7D

Tensioners for triple chain are provided on request only. / I tenditori per catena tripla si forniscono solo su richiesta.